

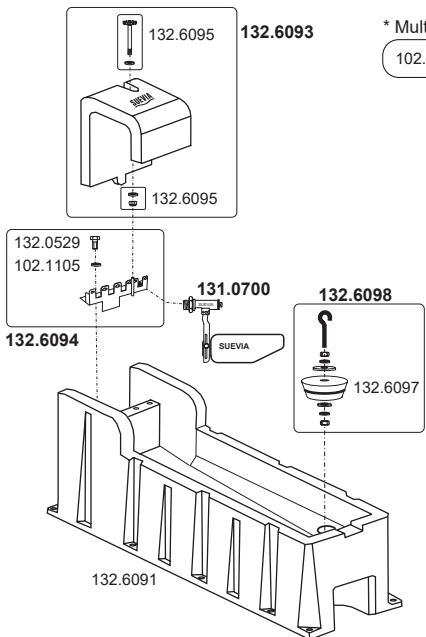







# 130.6523 Mod. 6523

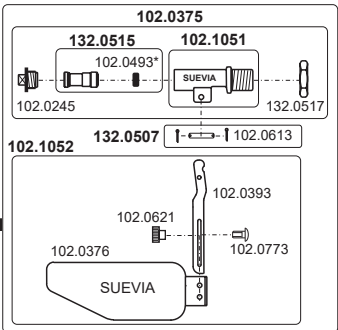
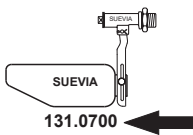



\* Multipack   
102.0493-10



**Zubehör • Accessories • Accessoires**

				
103.1985	101.0389	101.1099	101.0861	101.0390
			101.1863	101.0392

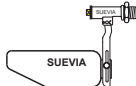
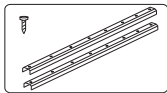
		
<b>131.0738</b>	<b>131.6069</b>	<b>131.6065</b>