

130.0620 Mod. 620 (> 11.2010)

* Multipack 
 102.0493-10

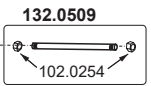

102.1490 1 1/4" (41 mm) (>03.2014)
132.0672 1" (33 mm) (<04.2014)

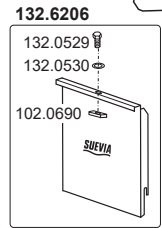
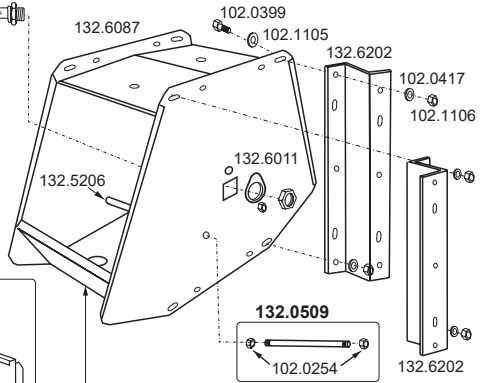
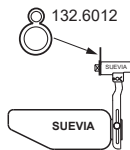
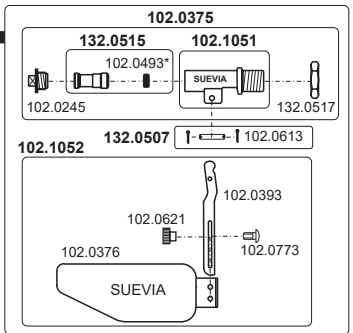
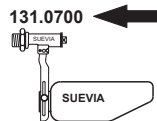