

Bayscreen Tracking

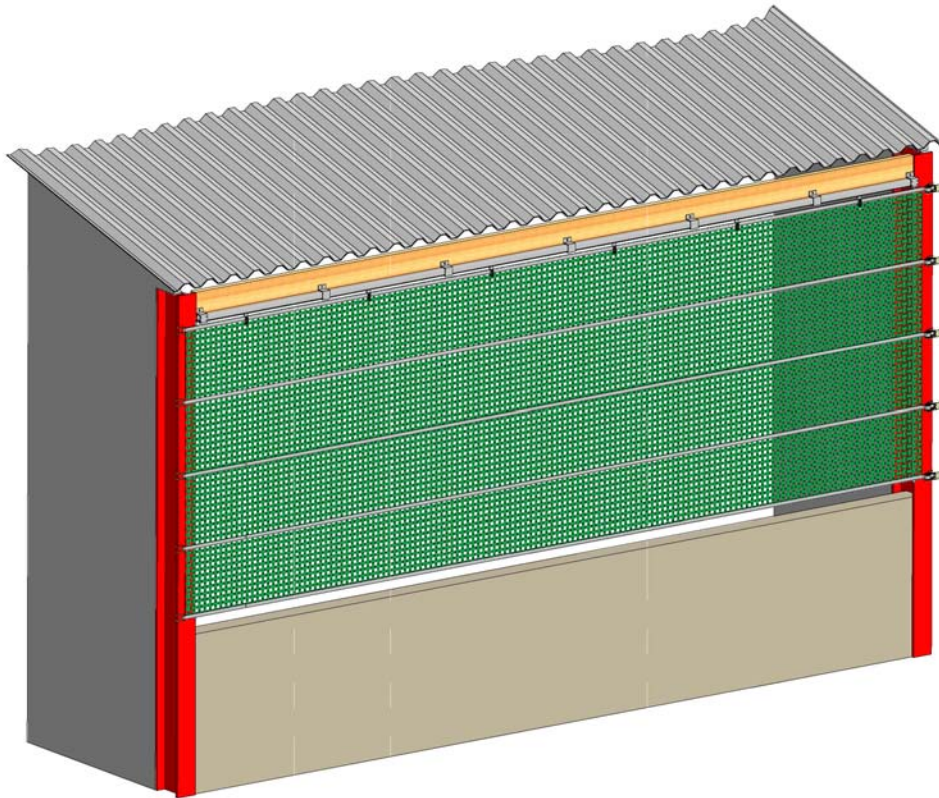

ENG

Supplement to Bayscreen Instructions



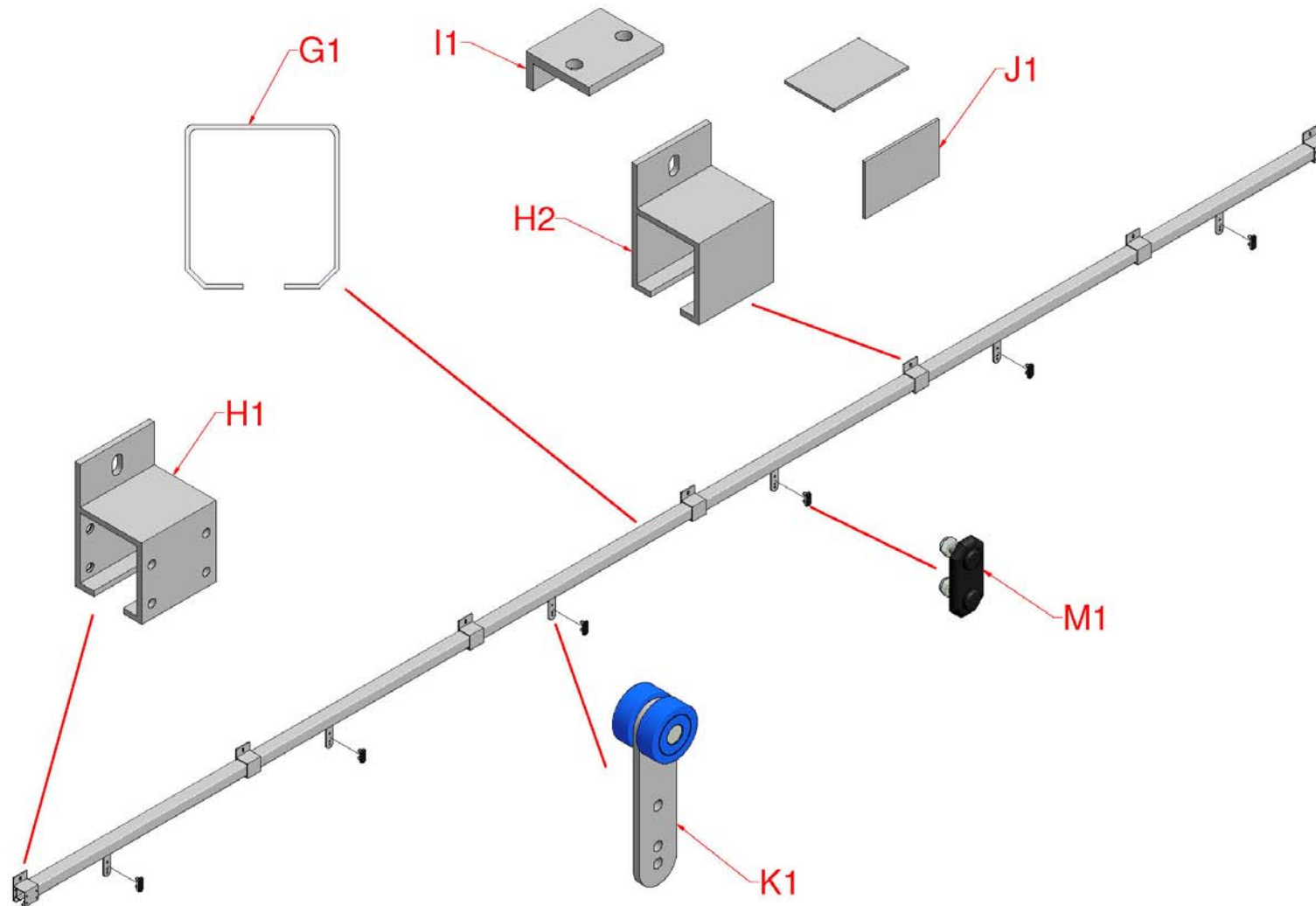

Figure 1, System Overview and Individual Components

INTRODUCTION

Parts List

Reference:	Quantity	Product Description
G1	*	Steel Tracking
H1	*	Five Hole Track Support Bracket (end)
H2	*	One Hole Track Support Bracket (intermediate)
I1	*	Track Adaptor Bracket
J1	*	Track Shim
K1	*	Two Wheel Trolley
L1	4	M6x60 C/sunk screw and nut for track bracket
M1	*	Trolley Clamp Plate and nuts
N1	*	M8x40mm Hex screw and nut for building fixing

ENG

* The system length dictates the quantities not stated

These instructions are a supplement to the Bayscreen Instructions for the fitting of the tracking and pulleys to the building where this option is required

Bolts for fixing the Track Brackets to a steel surface up to 25mm thick are supplied, alternative fixings are required for wood or concrete.

BUILDING REQUIREMENTS

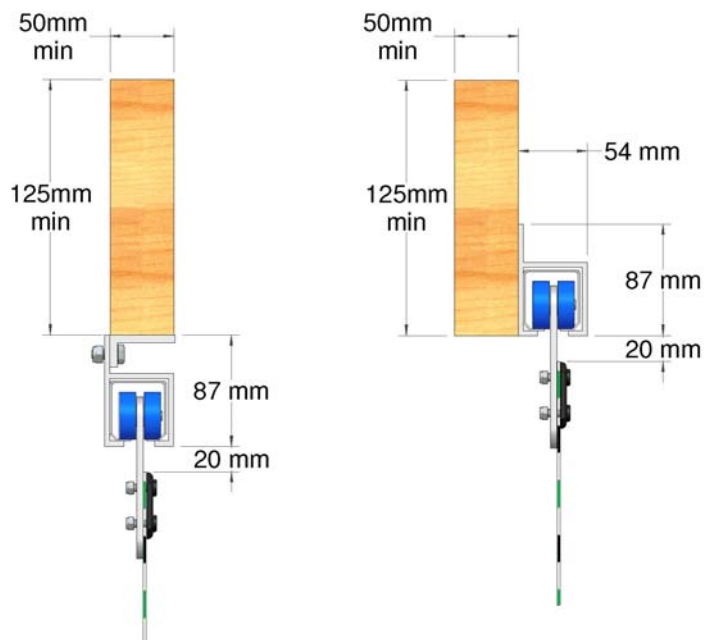

Figure 2, Building Requirements

INSTALLATION

1. Check the contents of your Bayscreen Tracking against the parts list using Figure 1. When initially installing the Bayscreen do not fully tension the sheet as indicated in Section 8 of the Bayscreen Installation Instructions.
2. Mark and drill two 6mm holes in the top webbing strap, 50cm from the outside edge, to match the studs of the trolley clamp plate (M1). Repeat along the length of the top strap at 100cm centres. For 25mm webbing the upper hole should be through the centre of the webbing with the lower hole through the screen, Figure 3a. For 50mm webbing both holes should be through the webbing, Figure 3b. Insert the trolley clamp plates into holes along the length.

ENG

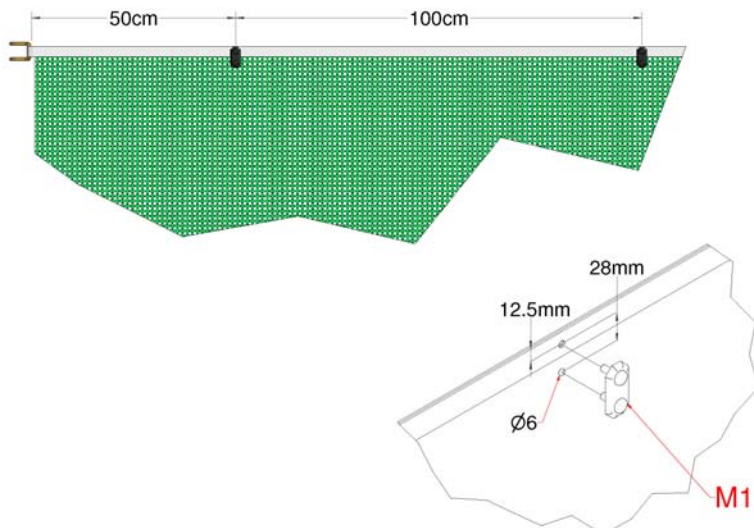
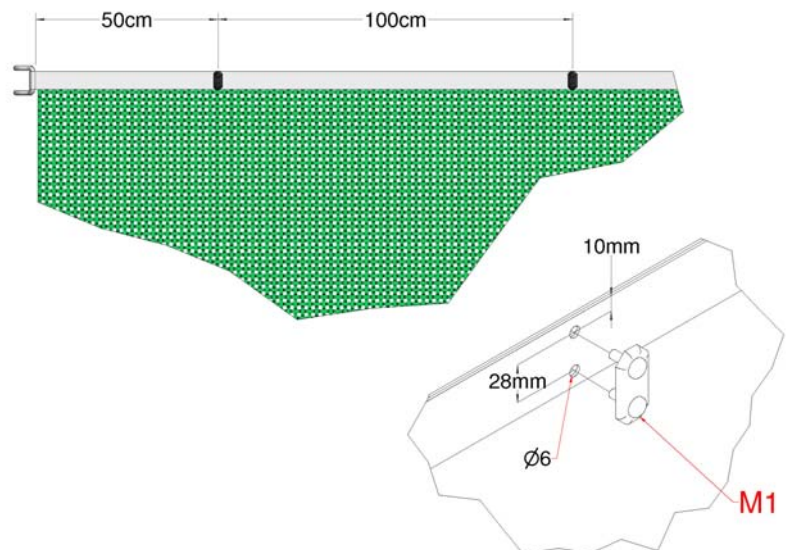



Figure 3a, Trolley Plates
(25mm webbing)

Figure 3b, Trolley Plates
(50mm webbing)



- Fasten the tracking onto the building with the M8x40mm bolts supplied (N1) or alternative. The orientation of the track support brackets (H1, H2 and I1) for face or lintel fixing to be the same as that decided when the order was placed, Figure 4. Support brackets to be positioned at 100cm centres. Insert the tracking with the track shims (J1) on the joints. To help in the smooth running of the trolleys file the ends of the tracking. Insert all the two wheeled trolleys (K1) into the track. Seal off the ends of the track by fixing the five hole track support brackets (H1) with the M6x60mm screws and nuts (L1).



CAUTION: Ensure the brackets are securely fastened to the building; failure of these fixings will result in potential injury to bystanders.

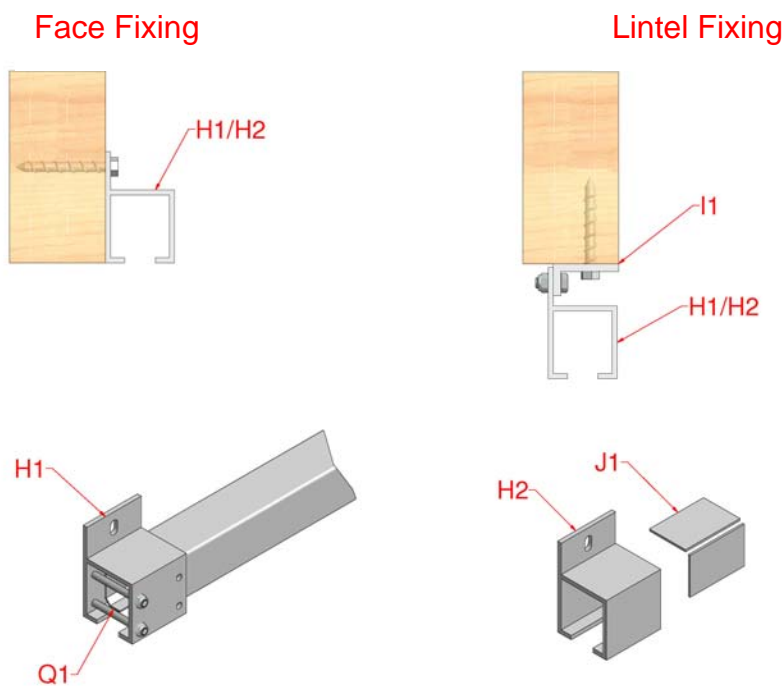

Figure 4, Track Fixing

- Raise the screen and attach the trolley clamp plates (M1) to the upper two holes in the trolley (K1) and secure with the M6 nyloc nuts, Figure 5.

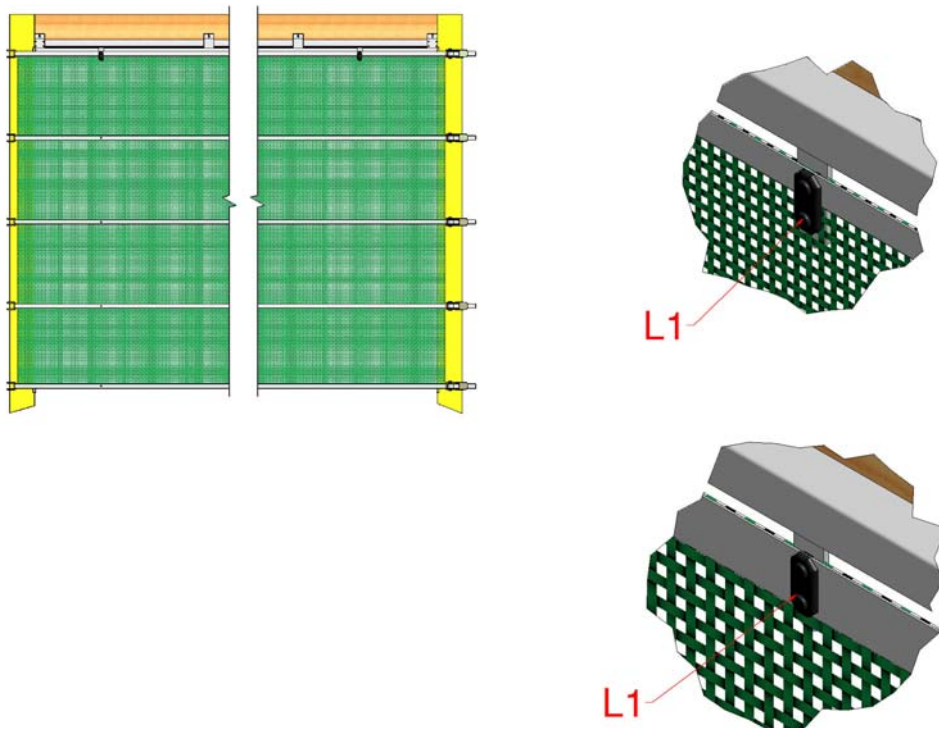

Figure 5, Attaching the Screen

5. Tighten all ratchets as firmly as possible, applying the tension equally to avoid wrinkles appearing in the material. Tension can be applied as firmly as possible by hand to the point where operation of the ratchet is no longer possible, but under no circumstances use levers to add more tension. Further trimming of the screen may be required.



ATTENTION: Tension ratchets fully, lack of tension will cause damage to the Slidescreen. Only tension by hand, use of levers could cause damage to the ratchets.



ATTENTION: To ensure the ratchet functions correctly there must be a minimum of 150mm webbing (for a 50mm ratchet) or 100mm webbing (25mm ratchet) around the ratchet barrel for secure & permanent tensioning of the screen.



ATTENTION: Overloading the ratchet barrel with webbing will restrict the tension you can apply to the screen due to an increase in friction and a decrease in leverage. To free surplus webbing pull ratchet release catch on handle and open 180 degrees until ratchet body is flat and pull on webbing strap.

ENG

YOUR BAYSCREEN WITH TRACKING IS READY FOR USE

How to use Your Bayscreen with Tracking

From the fully closed position, release the tension on the screen by pulling the ratchet release catch and opening the ratchet flat. Release the cranked hooks from the building at one end of the screen and slide the screen steadily along the track.

To close the screen reverse the above procedure, again using a steady action. It is essential that the screen is pulled tight to prevent screen damage during gusts of wind.

NOTE: The product has been tried and tested in the harshest weather conditions, a summary of our guarantee is listed below, see our website for full details:

- **Mechanical components: 100% guarantee for two years, followed by an eight year graduated guarantee.**

RAIN INGRESS: Please note that in extreme weather conditions some moisture will penetrate a mesh material.